

Chill

SPOT



DESCRIPTION

The Chill luminaire offers state-of-the-art accent lighting in a sleek, modern design.

Engineered with a specialized MIRO-Silver® reflector and complemented by an anti-glare ring, the Chill ensures optimal light distribution while providing visual comfort.



Anti-glare ring: for increased visual comfort provided by the honeycomb filter.



Small body size.
The lamp is ideal for any interior and will not distract unnecessary attention.



Large selection of opening angles.
With the help of various reflectors, the luminaire can create a narrow or wide beam of accent light.



General specifications

Type of luminaire	Spot (spot light module)
Application areas	Accent lighting
Supply unit	LED Driver integrated
Nominal voltage	230V, 50Hz
Lighting technology	LED COB
Optic	Aluminum reflector MIRO-Silver®
Power factor	0,95
Cooling	passive
Body	aluminum
Weight	1,24 kg
Package	Single / group
Life time	50 000 hours
Warranty	5 years/50 000 hours
Certification	CE, UKCA, UA

Dimensions

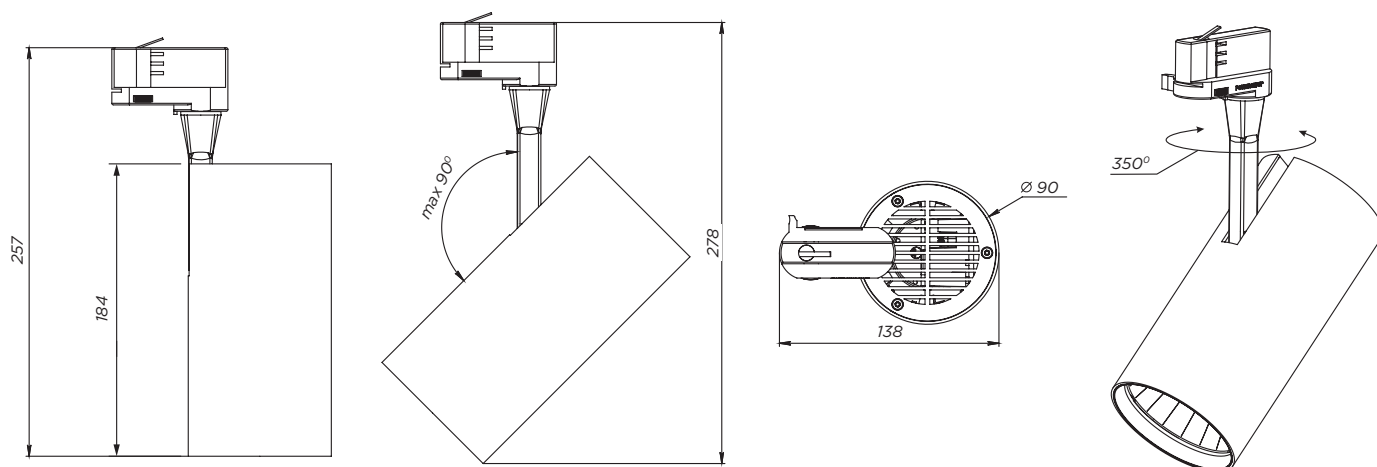

Scope of application



Chill

SPOT

Nomenclature

Luminaire SPOT Chill									
Order Type	Luminaire Filter Type	Luminaire Beam Angle	Luminaire Power, W	Luminaire Color Rendering Index (CRI)	Luminaire Color Temperature, K	Special Luminaire Light	Luminaire Mounting Type	Luminaire IP Rating	Luminaire Housing Color
SO	HF	15° 15°S 17°S 24° 36° 36°S 60° 62°x34° 34°x62°	13 15 17 19 22 24 27 30 32 34	8 9	3000 3500 4000 2700 3000 3500 4000	meat red meat white meat vivid elite bread bread vivid bakery cheese vegetables&fruits vegetables&fruits vivid fish white fish vivid fish premium color 3000 bright color 3000 bright color 3500 true white premium white 3000 premium white 3500 premium white 4000	3PH 1PH	IP21	BL black RAL 9005 WH white RAL9016

The deviation of actual power consumption from the specified values does not exceed ±5%;
 The luminous flux calculation is based on LEDs with a color temperature of 4000K, CRI80. The deviation of luminous flux from the specified values does not exceed ±10%

Beam angle

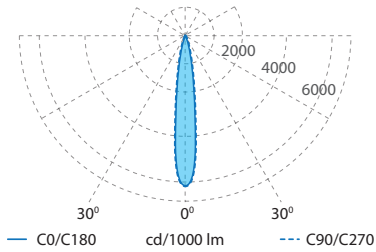

15°

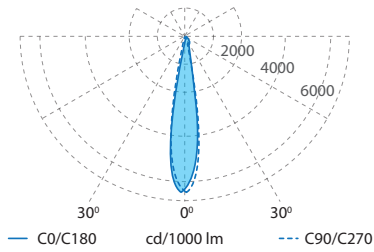

15°S

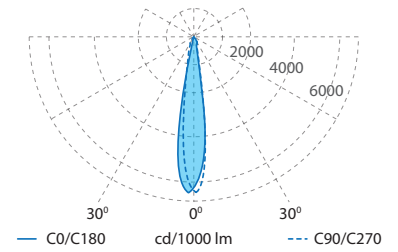

17°S

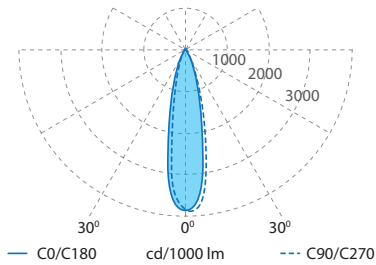

24°

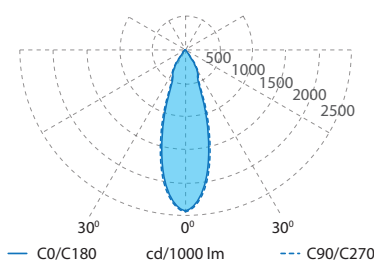

36°

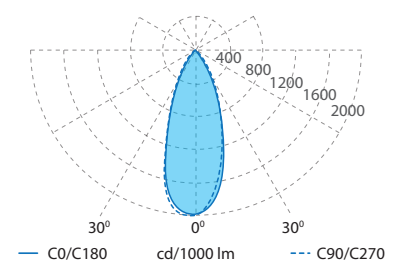

36°S

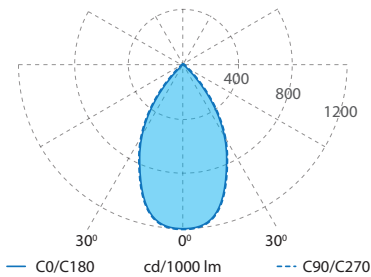

60°

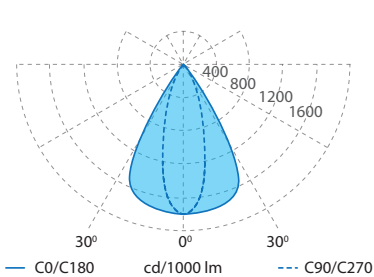

62°x34°

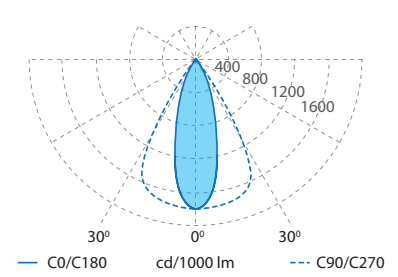

34°x62°

Technical details, as well as size and weight parameters were prepared as accurately as possible. All dimensions in mm. LED Lifetime Information - L90 / B10 at 25 °C ambient temperature. A tolerance of +/- 10% applies to luminous flux and performance characteristics. Minimum color rendering indices Ra > 80 / > 90. Product images are used as an example and may differ from the original. We reserve the right to make changes in order to improve the product.